



MPSA42/43

NPN SILICON TRANSISTOR

HIGH VOLTAGE TRANSISTOR

■ DESCRIPTION

The UTC **MPSA42/43** are high voltage transistors, designed for telephone switch and high voltage switch.

■ FEATURES

*Collector-Emitter voltage:

$V_{CE0}=300V$ (UTC MPSA42)

$V_{CE0}=200V$ (UTC MPSA43)

*High current gain

*Complement to UTC MPSA92/93

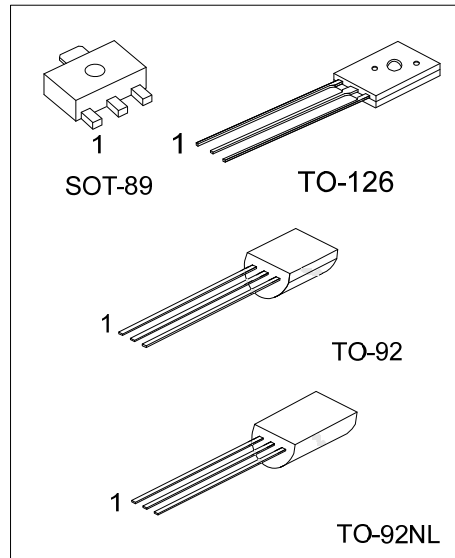

■ ORDERING INFORMATION

Ordering Number		Package	Pin Assignment			Packing
Lead Free	Halogen Free		1	2	3	
MPSA42L-AB3-R	MPSA42G-AB3-R	SOT-89	B	C	E	Tape Reel
MPSA42L-T60-K	MPSA42G-T60-K	TO-126	E	C	B	Bulk
MPSA42L-T92-B	MPSA42G-T92-B	TO-92	E	B	C	Tape Box
MPSA42L-T92-K	MPSA42G-T92-K	TO-92	E	B	C	Bulk
MPSA42L-T9N-B	MPSA42G-T9N-B	TO-92NL	E	C	B	Tape Box
MPSA42L-T9N-K	MPSA42G-T9N-K	TO-92NL	E	C	B	Bulk
MPSA43L-AB3-R	MPSA43G-AB3-R	SOT-89	B	C	E	Tape Reel
MPSA43L-T92-B	MPSA43G-T92-B	TO-92	E	B	C	Tape Box
MPSA43L-T92-K	MPSA43G-T92-K	TO-92	E	B	C	Bulk

Note: Pin Assignment: B: Base C: Collector E: Emitter

<p>MPSA42G-AB3-R</p> <p>(1)Packing Type</p> <p>(2)Package Type</p> <p>(3)Green Package</p>	<p>(1) B: Tape Box, K: Bulk, R: Tape Reel</p> <p>(2) AB3: SOT-89, T60: TO-126, T92: TO-92, T9N: TO-92NL</p> <p>(3) G: Halogen Free and Lead Free, L: Lead Free</p>
--	--

MARKING

Package	MPSA42	MPSA43
SOT-89	<p> Date Code L: Lead Free G: Halogen Free </p>	<p> Date Code L: Lead Free G: Halogen Free </p>
TO-126	<p> Date Code L: Lead Free G: Halogen Free </p>	—
TO-92	<p> L: Lead Free G: Halogen Free Date Code </p>	<p> L: Lead Free G: Halogen Free Date Code </p>
TO-92NL	<p> L: Lead Free G: Halogen Free Date Code </p>	—

■ ABSOLUTE MAXIMUM RATINGS (Operating temperature range applies unless otherwise specified)

PARAMETER		SYMBOL	RATINGS	UNIT
Collector-Base Voltage	MPSA42	V_{CBO}	300	V
	MPSA43		200	V
Collector-Emitter Voltage	MPSA42	V_{CEO}	300	V
	MPSA43		200	V
Emitter-Base Voltage		V_{EBO}	6	V
Collector Current		I_C	500	mA
Collector Dissipation ($T_A=25^\circ\text{C}$)	SOT-89	P_C	500	mW
	TO-126		1000	mW
	TO-92/TO-92NL		625	mW
Junction Temperature		T_J	150	$^\circ\text{C}$
Storage Temperature		T_{STG}	-55 ~ +150	$^\circ\text{C}$

Note: Absolute maximum ratings are those values beyond which the device could be permanently damaged. Absolute maximum ratings are stress ratings only and functional device operation is not implied.

■ THERMAL DATA

PARAMETER		SYMBOL	RATINGS	UNIT
Junction to Ambient	SOT-89	θ_{JA}	250	$^\circ\text{C/W}$
	TO-126		125	$^\circ\text{C/W}$
	TO-92/TO-92NL		200	$^\circ\text{C/W}$
Junction to Case	SOT-89	θ_{JC}	43	$^\circ\text{C/W}$
	TO-126		12.5	$^\circ\text{C/W}$
	TO-92/TO-92NL		83.3	$^\circ\text{C/W}$

■ ELECTRICAL CHARACTERISTICS ($T_J=25^\circ\text{C}$, unless otherwise specified)

PARAMETER		SYMBOL	TEST CONDITIONS	MIN	TYP	MAX	UNIT
Collector-Base Breakdown Voltage	MPSA42	BV_{CBO}	$I_C=100\mu\text{A}, I_E=0$	300			V
	MPSA43			200			V
Collector-Emitter Breakdown Voltage	MPSA42	BV_{CEO}	$I_C=1\text{mA}, I_B=0$	300			V
	MPSA43			200			V
Emitter-Base Breakdown Voltage		BV_{EBO}	$I_E=100\mu\text{A}, I_C=0$	6			V
Collector Cut-Off Current	MPSA42	I_{CBO}	$V_{CB}=200\text{V}, I_E=0$			100	nA
	MPSA43			$V_{CB}=160\text{V}, I_E=0$			100
Emitter Cut-Off Current	MPSA42	I_{EBO}	$V_{EB}=6\text{V}, I_C=0$			100	nA
	MPSA43			$V_{EB}=4\text{V}, I_C=0$			100
DC Current Gain		h_{FE}	$V_{CE}=10\text{V}, I_C=1\text{mA}$	80			
			$V_{CE}=10\text{V}, I_C=10\text{mA}$	80		300	
			$V_{CE}=10\text{V}, I_C=30\text{mA}$	80			
Collector-Emitter Saturation Voltage		$V_{CE(SAT)}$	$I_C=20\text{mA}, I_B=2\text{mA}$			0.2	V
Base-Emitter Saturation Voltage		$V_{BE(SAT)}$	$I_C=20\text{mA}, I_B=2\text{mA}$			0.90	V
Current Gain Bandwidth Product		f_T	$V_{CE}=20\text{V}, I_C=10\text{mA}, f=100\text{MHz}$	50			MHz
Collector Base Capacitance	MPSA42	C_{cb}	$V_{CB}=20\text{V}, I_E=0, f=1\text{MHz}$			3	pF
	MPSA43					4	pF

TYPICAL CHARACTERISTICS

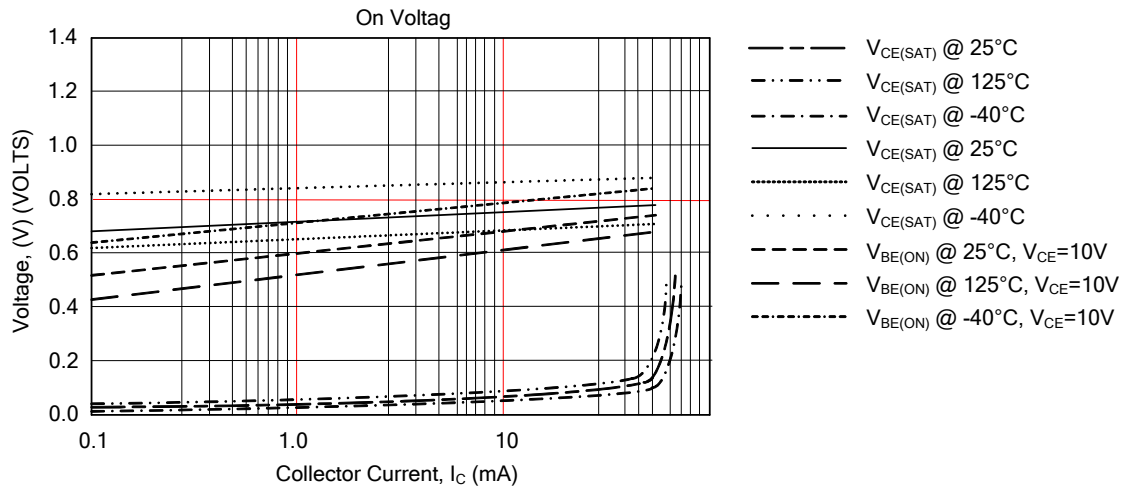
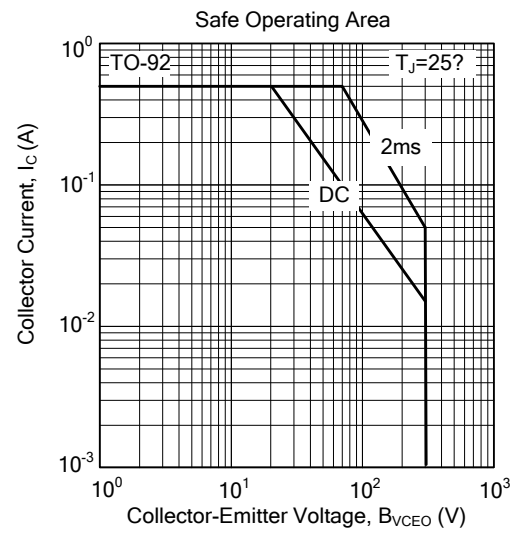
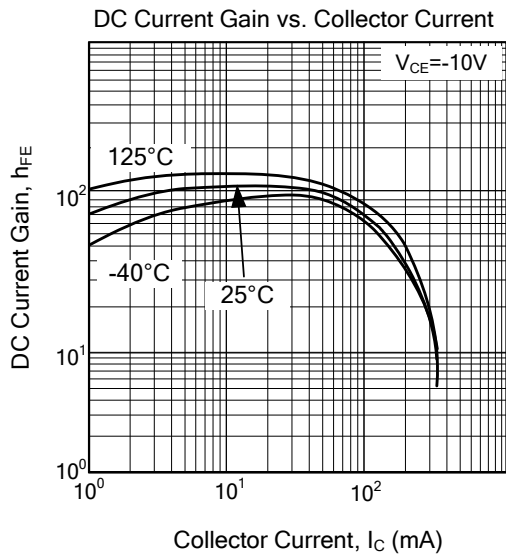
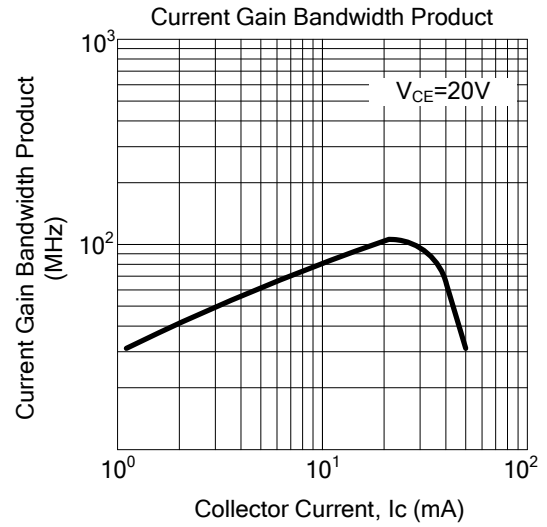
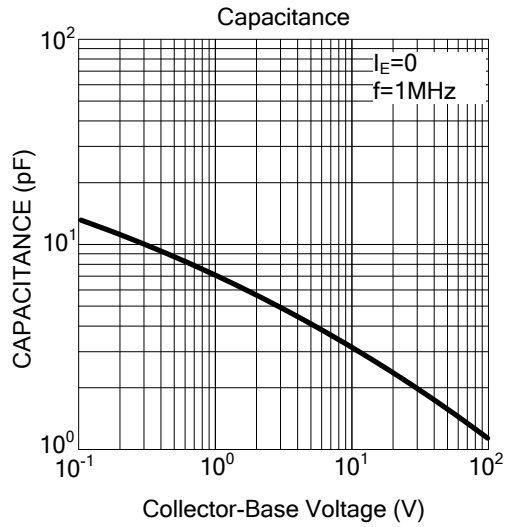

■ TYPICAL CHARACTERISTICS

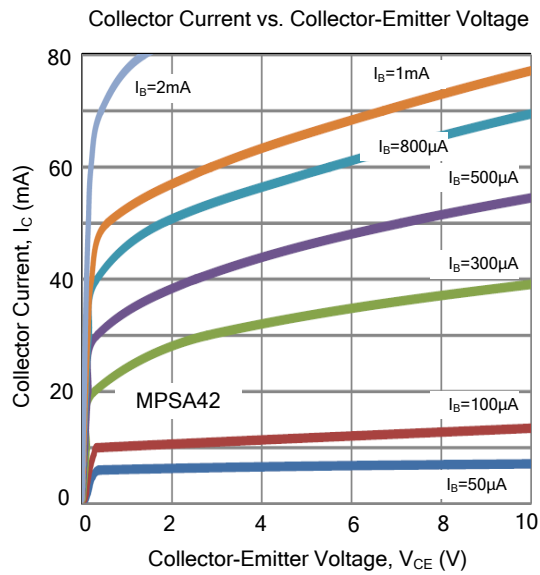

UTC assumes no responsibility for equipment failures that result from using products at values that exceed, even momentarily, rated values (such as maximum ratings, operating condition ranges, or other parameters) listed in products specifications of any and all UTC products described or contained herein. UTC products are not designed for use in life support appliances, devices or systems where malfunction of these products can be reasonably expected to result in personal injury. Reproduction in whole or in part is prohibited without the prior written consent of the copyright owner. UTC reserves the right to make changes to information published in this document, including without limitation specifications and product descriptions, at any time and without notice. This document supersedes and replaces all information supplied prior to the publication hereof.