



2SD669/A

NPN SILICON TRANSISTOR

BIPOLAR POWER GENERAL PURPOSE TRANSISTOR

■ APPLICATIONS

* Low frequency power amplifier complementary pair with UTC 2SB649/A

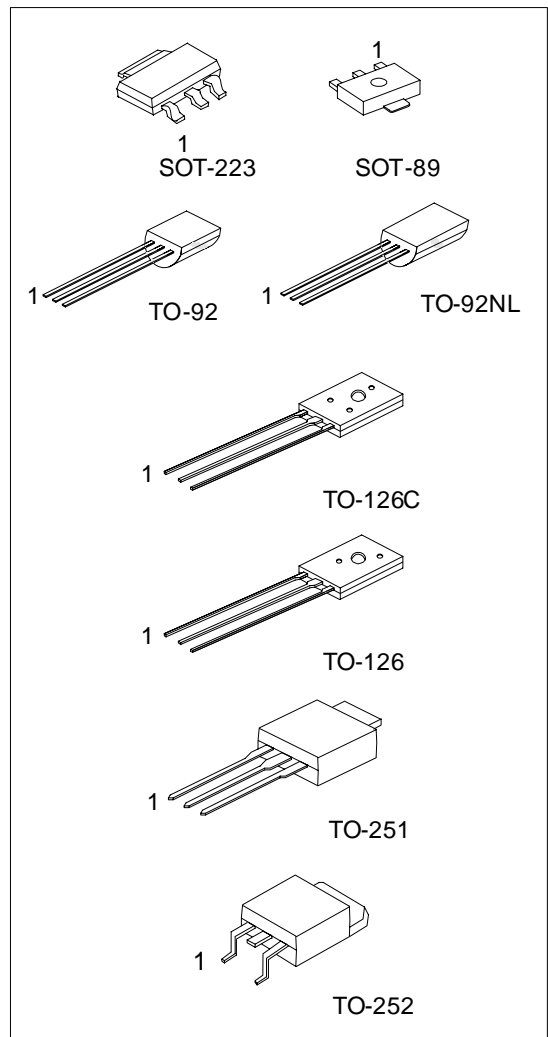

*Pb-free plating product number:
2SD669L/2SD669AL

■ ORDERING INFORMATION

Order Number		Package	Pin Assignment			Packing
Normal	Lead Free Plating		1	2	3	
2SD669-x-AA3-R	2SD669L-x-AA3-R	SOT-223	B	C	E	Tape Reel
2SD669-x-AB3-R	2SD669L-x-AB3-R	SOT-89	B	C	E	Tape Reel
2SD669-x-T60-K	2SD669L-x-T60-K	TO-126	E	C	B	Bulk
2SD669-x-T6C-R	2SD669L-x-T6C-R	TO-126C	E	C	B	Bulk
2SD669-x-T92-B	2SD669L-x-T92-B	TO-92	E	C	B	Tape Box
2SD669-x-T92-K	2SD669L-x-T92-K	TO-92	E	C	B	Bulk
2SD669-x-T9N-B	2SD669L-x-T9N-B	TO-92NL	E	C	B	Tape Box
2SD669-x-T9N-K	2SD669L-x-T9N-K	TO-92NL	E	C	B	Bulk
2SD669-x-T9N-R	2SD669L-x-T9N-R	TO-92NL	E	C	B	Tape Reel
2SD669-x-TM3-T	2SD669L-x-TM3-T	TO-251	E	C	B	Tube
2SD669-x-TN3-R	2SD669L-x-TN3-R	TO-252	B	C	E	Tape Reel
2SD669-x-TN3-T	2SD669L-x-TN3-T	TO-252	B	C	E	Tube

■ ORDERING INFORMATION(Cont.)

Order Number		Package	Pin Assignment			Packing
Normal	Lead Free Plating		1	2	3	
2SD669A-x-AA3-R	2SD669AL-x-AA3-R	SOT-223	B	C	E	Tape Reel
2SD669A-x-AB3-R	2SD669AL-x-AB3-R	SOT-89	B	C	E	Tape Reel
2SD669A-x-T60-K	2SD669AL-x-T60-K	TO-126	E	C	B	Bulk
2SD669A-x-T6C-R	2SD669AL-x-T6C-R	TO-126C	E	C	B	Bulk
2SD669A-x-T92-B	2SD669AL-x-T92-B	TO-92	E	C	B	Tape Box
2SD669A-x-T92-K	2SD669AL-x-T92-K	TO-92	E	C	B	Bulk
2SD669A-x-T9N-B	2SD669AL-x-T9N-B	TO-92NL	E	C	B	Tape Box
2SD669A-x-T9N-K	2SD669AL-x-T9N-K	TO-92NL	E	C	B	Bulk
2SD669A-x-T9N-R	2SD669AL-x-T9N-R	TO-92NL	E	C	B	Tape Reel
2SD669A-x-TM3-T	2SD669AL-x-TM3-T	TO-251	E	C	B	Tube
2SD669A-x-TN3-R	2SD669AL-x-TN3-R	TO-252	B	C	E	Tape Reel
2SD669A-x-TN3-T	2SD669AL-x-TN3-T	TO-252	B	C	E	Tube

<p>2SD669L-x-AB3-R</p> <p>(1)Packing Type (2)Package Type (3)Rank (4)Lead Plating</p>	<p>(1) K: Bulk, R: Tape Reel, T: Tube (2) AA3: SOT-223, AB3: SOT-89, T60: TO-126, T6C: TO-126C, TM3: TO-251, TN3: TO-252, T92: TO-92, T9N: TO-92NL (3) x: refer to Classification of h_{FE1} (4) L: Lead Free Plating, Blank: Pb/Sn</p>
---	--

■ ABSOLUTE MAXIMUM RATING (Ta=25 , unless otherwise specified)

PARAMETER	SYMBOL	RATINGS	UNIT	
Collector-Base Voltage	V _{CB0}	180	V	
Collector-Emitter Voltage	2SD669	120	V	
	2SD669A	160		
Emitter-Base Voltage	V _{EBO}	5	V	
Collector Current	I _C	1.5	A	
Collector Peak Current	I _{C(PK)}	3	A	
Collector Power Dissipation	P _D	SOT-223	0.5	W
Collector Power Dissipation		TO-126	1	W
Junction Temperature	T _J	+150		
Storage Temperature	T _{STG}	-40 ~ +150		

Note Absolute maximum ratings are those values beyond which the device could be permanently damaged. Absolute maximum ratings are stress ratings only and functional device operation is not implied.

■ ELECTRICAL CHARACTERISTICS (Ta=25 , unless otherwise specified)

PARAMETER	SYMBOL	TEST CONDITIONS	MIN	TYP	MAX	UNIT
Collector to Base Breakdown Voltage	BV _{CB0}	I _C =1mA, I _E =0	180			V
Collector to Emitter Breakdown Voltage	BV _{CEO}	I _C =10mA, R _{BE} =∞	2SD669	120		V
			2SD669A	160		
Emitter to Base Breakdown Voltage	BV _{EBO}	I _E =1mA, I _C =0	5			V
Collector Cut-off Current	I _{CB0}	V _{CB} =160V, I _E =0			10	μA
DC Current Gain	h _{FE1}	V _{CE} =5V, I _C =150mA (Note)	60		320	
	h _{FE2}	V _{CE} =5V, I _C =500mA (Note)	30			
Collector-Emitter Saturation Voltage	V _{CE(SAT)}	I _C =600mA, I _B =50mA (Note)			1	V
Base-Emitter Voltage	V _{BE}	V _{CE} =5V, I _C =150mA (Note)			1.5	V
Current Gain Bandwidth Product	f _T	V _{CE} =5V, I _C =150mA (Note)		140		MHz
Output Capacitance	C _{ob}	V _{CB} =10V, I _E =0, f=1MHz		14		pF

Note: Pulse test.

■ CLASSIFICATION OF h_{FE1}

RANK	B	C	D
RANGE	60-120	100-200	160-320

TYPICAL CHARACTERISTICS

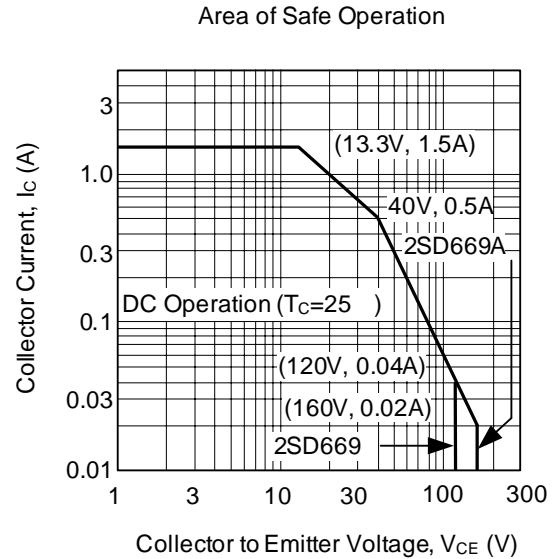
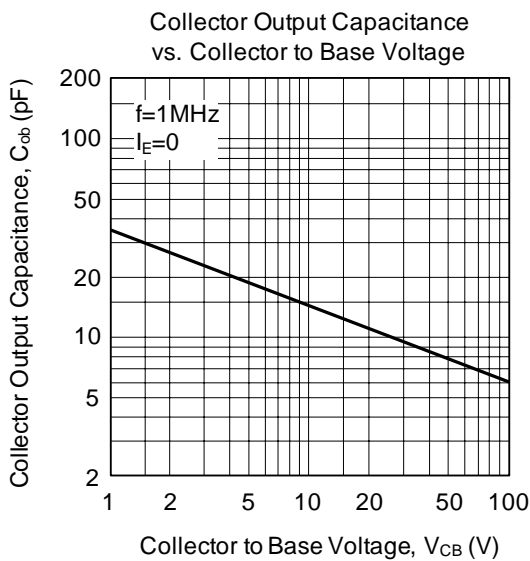
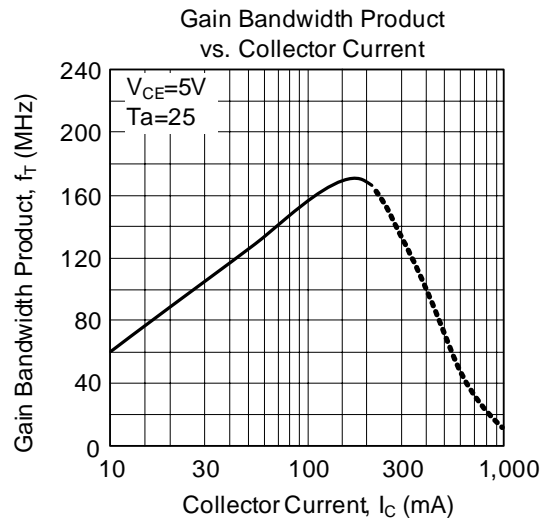
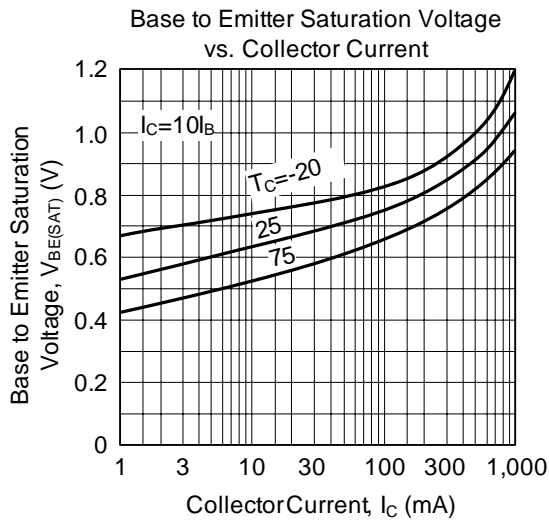
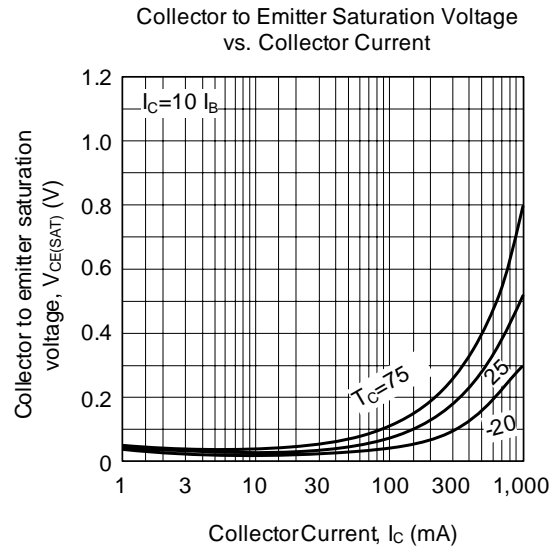
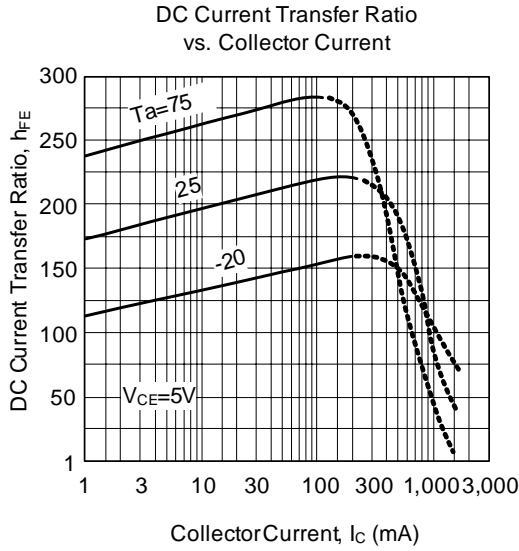

■ TYPICAL CHARACTERISTICS(Cont.)

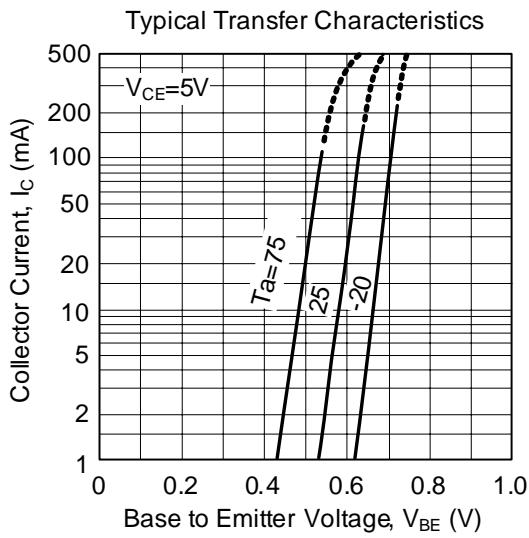

UTC assumes no responsibility for equipment failures that result from using products at values that exceed, even momentarily, rated values (such as maximum ratings, operating condition ranges, or other parameters) listed in products specifications of any and all UTC products described or contained herein. UTC products are not designed for use in life support appliances, devices or systems where malfunction of these products can be reasonably expected to result in personal injury. Reproduction in whole or in part is prohibited without the prior written consent of the copyright owner. The information presented in this document does not form part of any quotation or contract, is believed to be accurate and reliable and may be changed without notice.