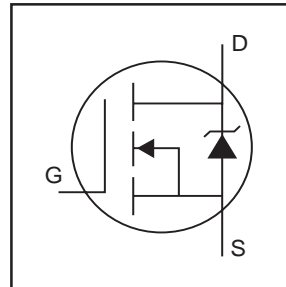


# IRFI530NPbF

## HEXFET® Power MOSFET

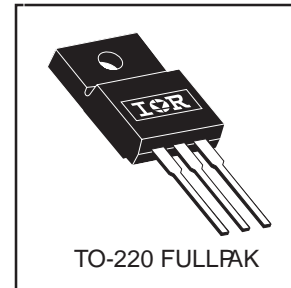
- Advanced Process Technology
- Isolated Package
- High Voltage Isolation = 2.5KVRMS ⑤
- Sink to Lead Creepage Dist. = 4.8mm
- Fully Avalanche Rated
- Lead-Free



$V_{DSS} = 100V$
$R_{DS(on)} = 0.11\Omega$
$I_D = 12A$

### Description

Fifth Generation HEXFETs from International Rectifier utilize advanced processing techniques to achieve the lowest possible on-resistance per silicon area. This benefit, combined with the fast switching speed and ruggedized device design that HEXFET Power MOSFETs are well known for, provides the designer with an extremely efficient device for use in a wide variety of applications.



The TO-220 Fullpak eliminates the need for additional insulating hardware in commercial-industrial applications. The moulding compound used provides a high isolation capability and a low thermal resistance between the tab and external heatsink. This isolation is equivalent to using a 100 micron mica barrier with standard TO-220 product. The Fullpak is mounted to a heatsink using a single clip or by a single screw fixing.

### Absolute Maximum Ratings

	Parameter	Max.	Units
$I_D @ T_C = 25^\circ C$	Continuous Drain Current, $V_{GS} @ 10V$	12	A
$I_D @ T_C = 100^\circ C$	Continuous Drain Current, $V_{GS} @ 10V$	8.6	
$I_{DM}$	Pulsed Drain Current ①⑥	60	
$P_D @ T_C = 25^\circ C$	Power Dissipation	41	W
	Linear Derating Factor	0.27	W/°C
$V_{GS}$	Gate-to-Source Voltage	$\pm 20$	V
$E_{AS}$	Single Pulse Avalanche Energy ②⑥	150	mJ
$I_{AR}$	Avalanche Current ①⑥	9.0	A
$E_{AR}$	Repetitive Avalanche Current ①	4.1	mJ
dv/dt	Peak Diode Recovery dv/dt ③⑥	5.0	V/ns
$T_J$	Operating Junction and	-55 to + 175	°C
$T_{STG}$	Storage Temperature Range		
	Soldering Temperature, for 10 seconds		
	Mounting torque, 6-32 or M3 screw.	10 lbf•in (1.1N•m)	

### Thermal Resistance

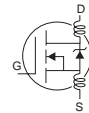
	Parameter	Min.	Typ.	Max.	Units
$R_{\theta JC}$	Junction-to-Case	---	---	3.7	°C/W
$R_{\theta JA}$	Junction-to-Ambient	---	---	65	

# IRFI530NPbF

International  
**IR** Rectifier

## Electrical Characteristics @ $T_J = 25^\circ\text{C}$ (unless otherwise specified)

	Parameter	Min.	Typ.	Max.	Units	Conditions
$V_{(BR)DSS}$	Drain-to-Source Breakdown Voltage	100	—	—	V	$V_{GS} = 0V, I_D = 250\mu A$
$\Delta V_{(BR)DSS}/\Delta T_J$	Breakdown Voltage Temp. Coefficient	—	0.12	—	V/ $^\circ\text{C}$	Reference to $25^\circ\text{C}, I_D = 1\text{mA}$ ④
$R_{DS(on)}$	Static Drain-to-Source On-Resistance	—	—	0.11	$\Omega$	$V_{GS} = 10V, I_D = 6.6A$ ④
$V_{GS(th)}$	Gate Threshold Voltage	2.0	—	4.0	V	$V_{DS} = V_{GS}, I_D = 250\mu A$
$g_{fs}$	Forward Transconductance	6.4	—	—	S	$V_{DS} = 50V, I_D = 9.0A$ ⑥
$I_{DSS}$	Drain-to-Source Leakage Current	—	—	25	$\mu A$	$V_{DS} = 100V, V_{GS} = 0V$
		—	—	250		$V_{DS} = 80V, V_{GS} = 0V, T_J = 150^\circ\text{C}$
$I_{GSS}$	Gate-to-Source Forward Leakage	—	—	100	nA	$V_{GS} = 20V$
	Gate-to-Source Reverse Leakage	—	—	-100		$V_{GS} = -20V$
$Q_g$	Total Gate Charge	—	—	44	nC	$I_D = 9.0A$
$Q_{gs}$	Gate-to-Source Charge	—	—	6.2		$V_{DS} = 80V$
$Q_{gd}$	Gate-to-Drain ("Miller") Charge	—	—	21		$V_{GS} = 10V$ , See Fig. 6 and 13 ④ ⑥
$t_{d(on)}$	Turn-On Delay Time	—	6.4	—	ns	$V_{DD} = 50V$
$t_r$	Rise Time	—	27	—		$I_D = 9.0A$
$t_{d(off)}$	Turn-Off Delay Time	—	37	—		$R_G = 12\Omega$
$t_f$	Fall Time	—	25	—		$R_D = 5.5\Omega$ , See Fig. 10 ④ ⑥
$L_D$	Internal Drain Inductance	—	4.5	—	nH	Between lead, 6mm (0.25in.) from package and center of die contact
$L_S$	Internal Source Inductance	—	7.5	—		
$C_{iss}$	Input Capacitance	—	640	—	pF	$V_{GS} = 0V$
$C_{oss}$	Output Capacitance	—	160	—		$V_{DS} = 25V$
$C_{rss}$	Reverse Transfer Capacitance	—	88	—		$f = 1.0\text{MHz}$ , See Fig. 5 ⑥
C	Drain to Sink Capacitance	—	12	—		$f = 1.0\text{MHz}$

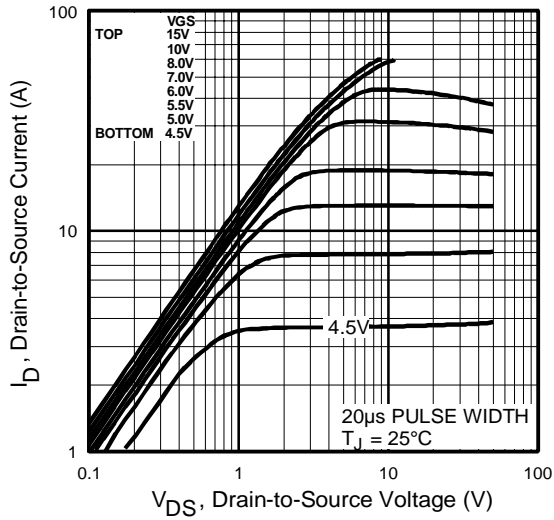


## Source-Drain Ratings and Characteristics

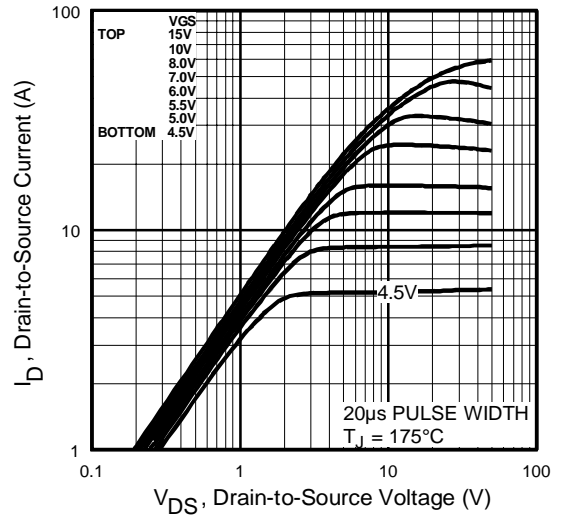
	Parameter	Min.	Typ.	Max.	Units	Conditions
$I_S$	Continuous Source Current (Body Diode)	—	—	12	A	MOSFET symbol showing the integral reverse p-n junction diode.
$I_{SM}$	Pulsed Source Current (Body Diode) ① ⑥	—	—	60		
$V_{SD}$	Diode Forward Voltage	—	—	1.3	V	$T_J = 25^\circ\text{C}, I_S = 6.6A, V_{GS} = 0V$ ④
$t_{rr}$	Reverse Recovery Time	—	130	190	ns	$T_J = 25^\circ\text{C}, I_F = 9.0A$
$Q_{rr}$	Reverse Recovery Charge	—	650	970	nC	$di/dt = 100A/\mu s$ ④ ⑥

### Notes:

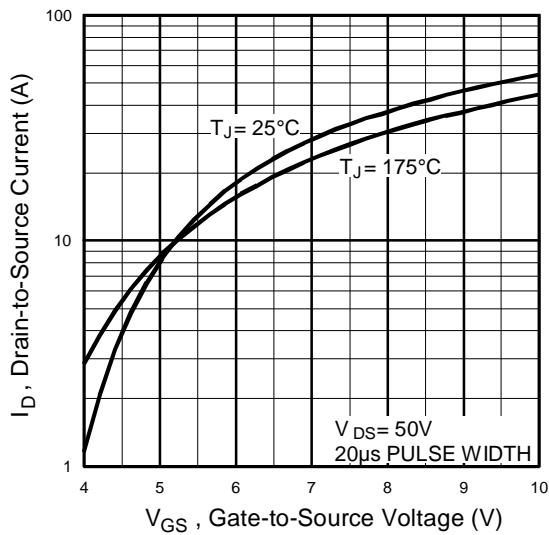
- ① Repetitive rating; pulse width limited by max. junction temperature. ( See fig. 11 )
- ②  $V_{DD} = 15V$ , starting  $T_J = 25^\circ\text{C}$ ,  $L = 3.1\text{mH}$   
 $R_G = 25\Omega, I_{AS} = 9.0A$ . (See Figure 12)
- ③  $I_{SD} \leq 9.0A, di/dt \leq 520A/\mu s, V_{DD} \leq V_{(BR)DSS}, T_J \leq 175^\circ\text{C}$
- ④ Pulse width  $\leq 300\mu s$ ; duty cycle  $\leq 2\%$ .
- ⑤  $t = 60s, f = 60\text{Hz}$
- ⑥ Uses IRF530N data and test conditions



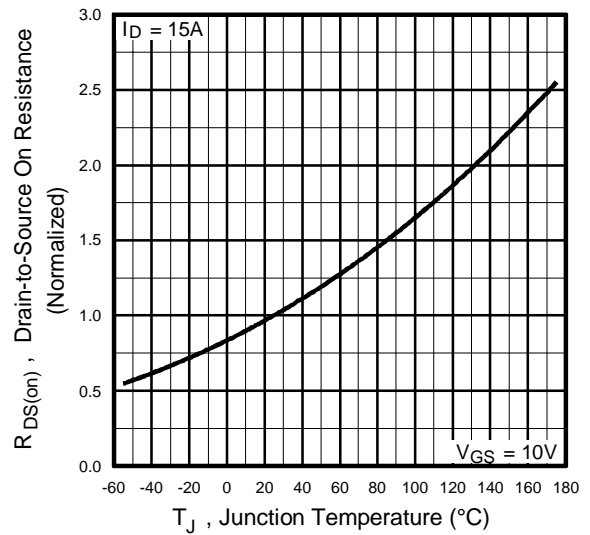
**Fig 1.** Typical Output Characteristics



**Fig 2.** Typical Output Characteristics

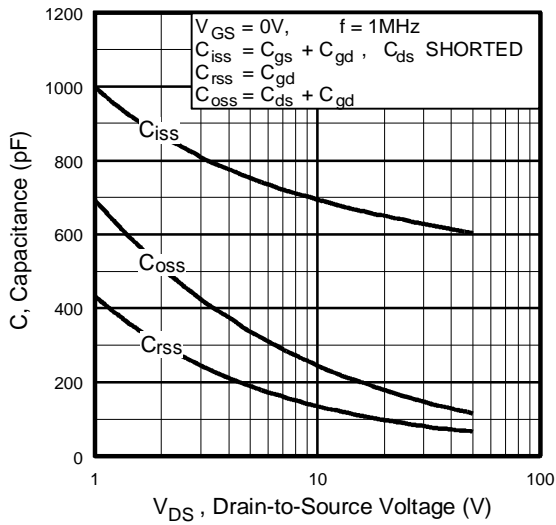


**Fig 3.** Typical Transfer Characteristics

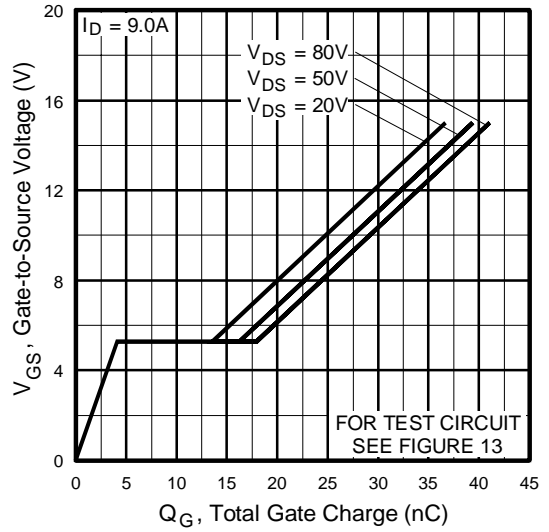


**Fig 4.** Normalized On-Resistance Vs. Temperature

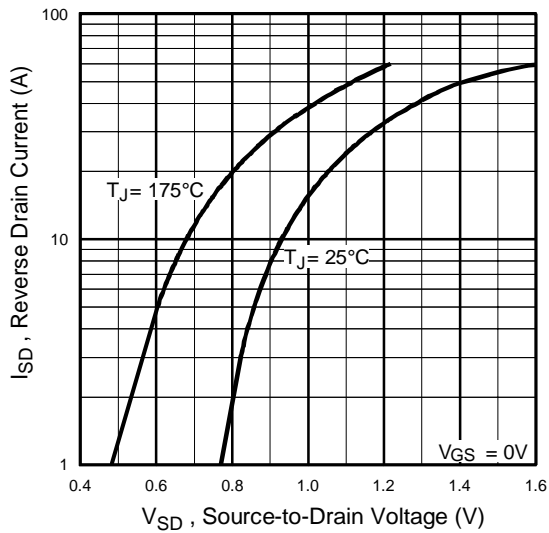
# IRFI530NPbF



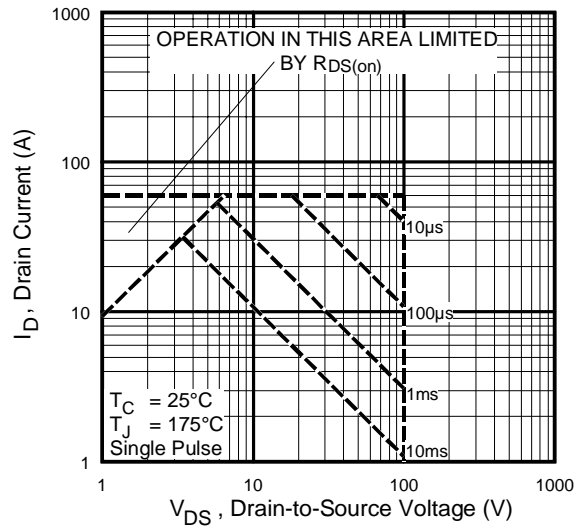
**Fig 5.** Typical Capacitance Vs. Drain-to-Source Voltage



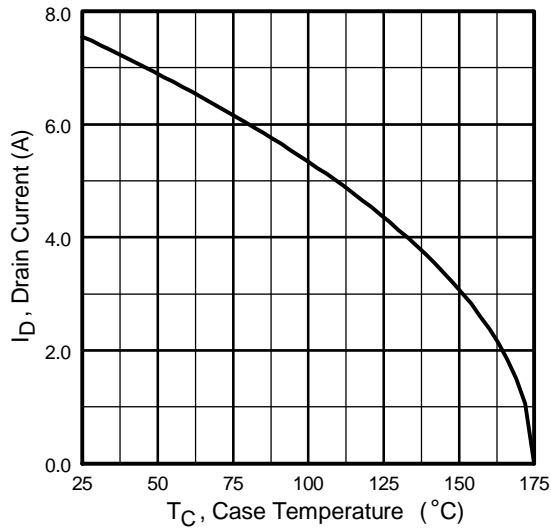
**Fig 6.** Typical Gate Charge Vs. Gate-to-Source Voltage



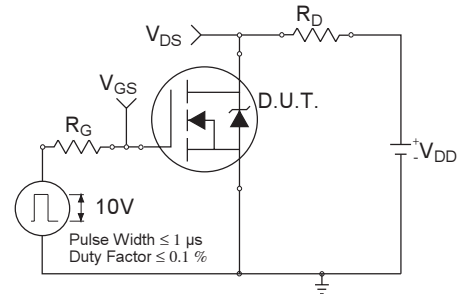
**Fig 7.** Typical Source-Drain Diode Forward Voltage



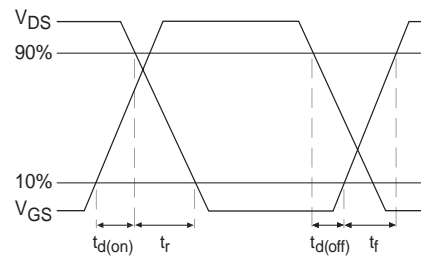
**Fig 8.** Maximum Safe Operating Area



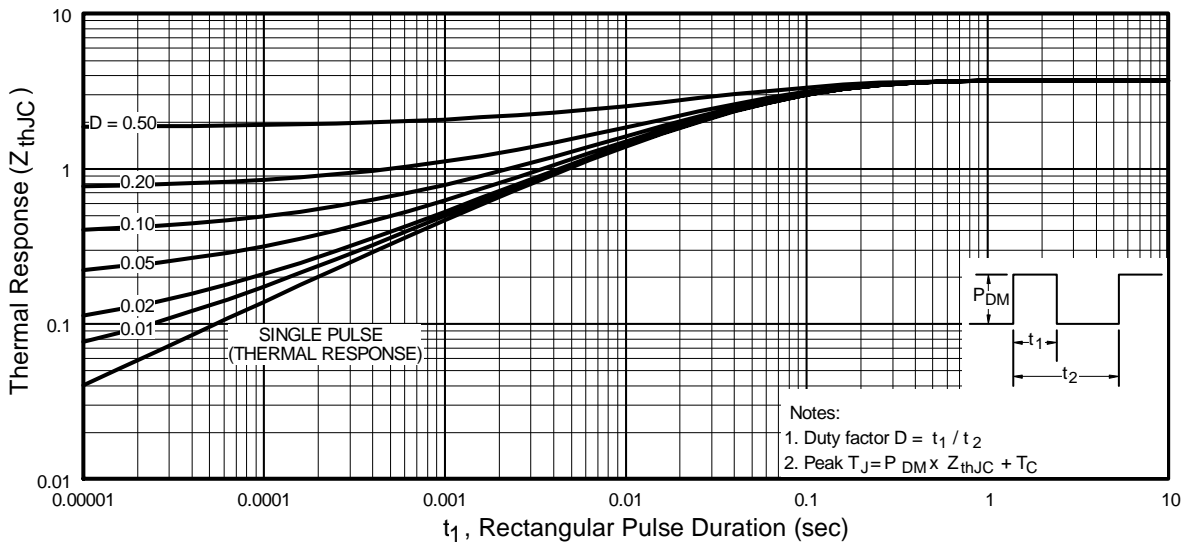
**Fig 9.** Maximum Drain Current Vs. Case Temperature



**Fig 10a.** Switching Time Test Circuit



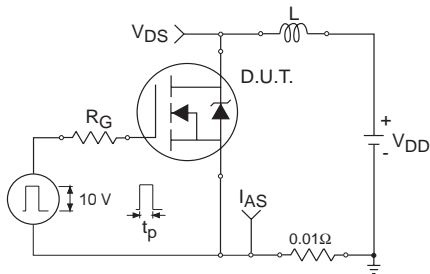
**Fig 10b.** Switching Time Waveforms



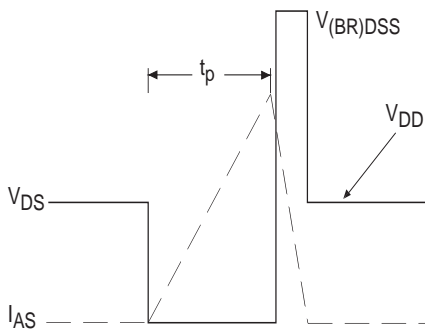
**Fig 11.** Maximum Effective Transient Thermal Impedance, Junction-to-Case

# IRFI530NPbF

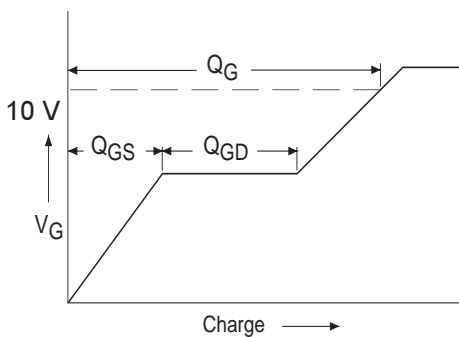
International  
**IR** Rectifier



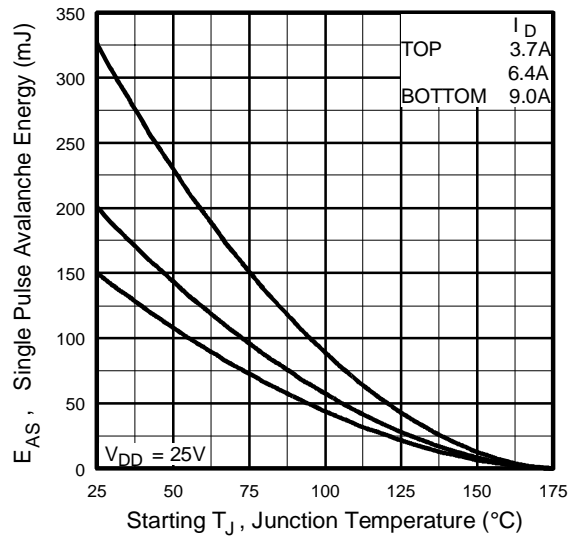
**Fig 12a.** Unclamped Inductive Test Circuit



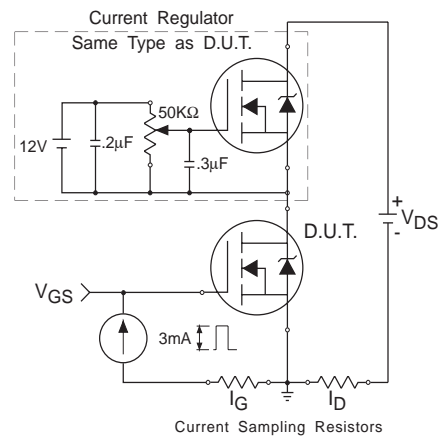
**Fig 12b.** Unclamped Inductive Waveforms



**Fig 13a.** Basic Gate Charge Waveform

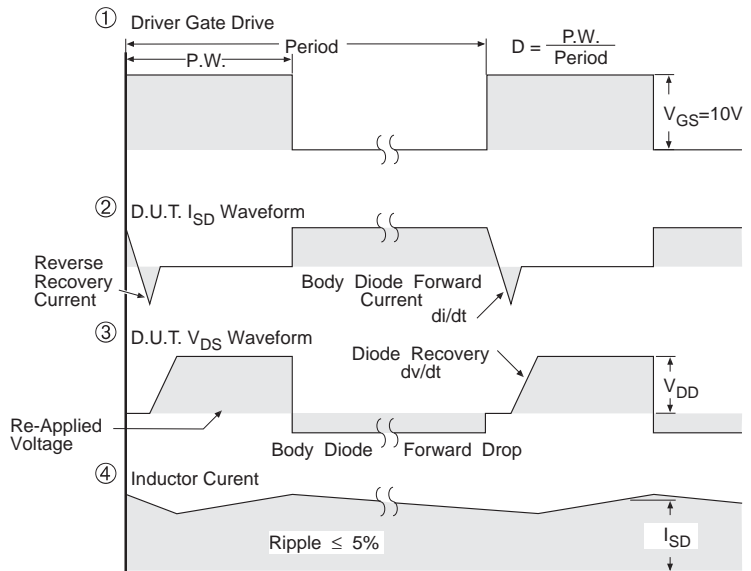
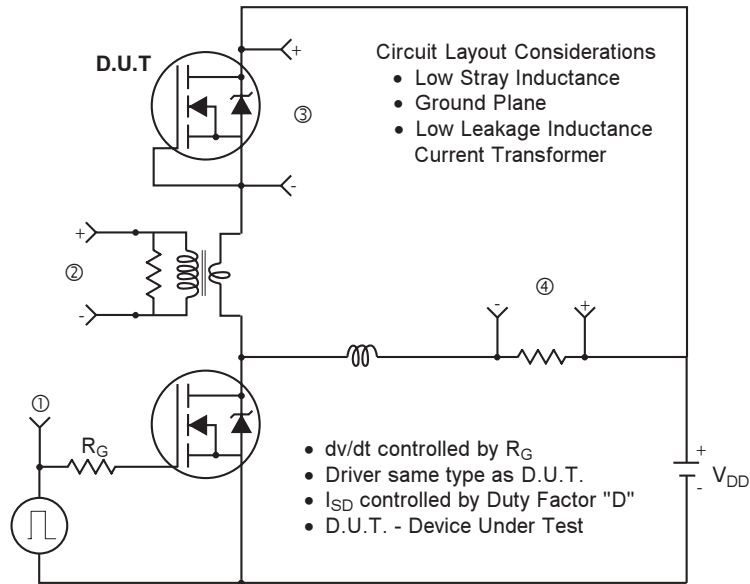


**Fig 12c.** Maximum Avalanche Energy Vs. Drain Current



**Fig 13b.** Gate Charge Test Circuit

## Peak Diode Recovery dv/dt Test Circuit



\*  $V_{GS} = 5V$  for Logic Level Devices

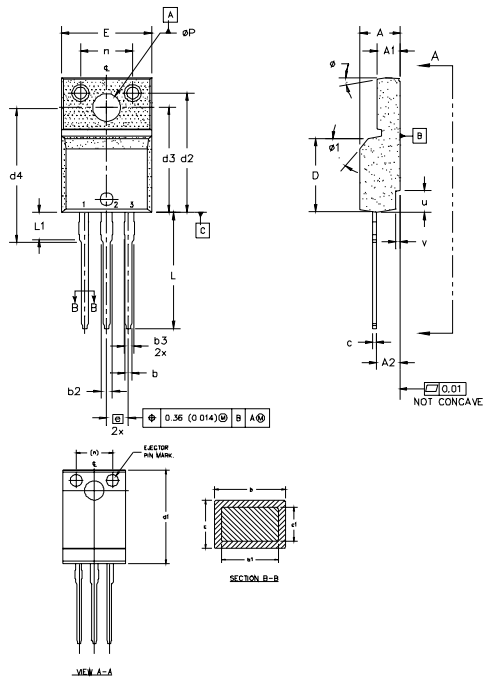
**Fig 14.** For N-Channel HEXFETS

# IRFI530NPbF

International  
**IOR** Rectifier

## TO-220 Full-Pak Package Outline

Dimensions are shown in millimeters (inches)



- NOTES:
- 1.0 DIMENSIONING AND TOLERANCING PER ASME Y14.5 M- 1994.
  - 2.0 DIMENSIONS ARE SHOWN IN MILLIMETERS [INCHES]
  - 3.0 LEAD DIMENSION AND FINISH UNCONTROLLED IN L1.
  - 4.0 DIMENSION D & E DO NOT INCLUDE MOLD FLASH. MOLD FLASH SHALL NOT EXCEED 0.005" (0.127) PER SIDE. THESE DIMENSIONS ARE MEASURED AT THE QUOTERMOST EXTREMES OF THE PLASTIC BODY.
  - 5.0 DIMENSION B1 APPLY TO BASE METAL ONLY.
  - 6.0 STEP OPTIONAL ON PLASTIC BODY DEFINED BY DIMENSIONS u & v.
  - 7.0 CONTROLLING DIMENSION - INCHES.

SYMBOL	DIMENSIONS				NOTES
	MILLIMETERS		INCHES		
A	4.57	4.83	0.180	0.190	
A1	2.57	2.83	0.101	0.114	
A2	2.51	2.85	0.099	0.112	
b	0.622	0.69	0.024	0.026	
b1	0.622	0.838	0.024	0.033	5
b2	1.229	1.400	0.048	0.055	
b3	1.229	1.400	0.048	0.055	
c	0.440	0.629	0.017	0.025	
c1	0.440	0.584	0.017	0.023	
D	8.65	9.80	0.341	0.386	4
d1	15.80	16.12	0.622	0.635	
d2	13.97	14.22	0.550	0.560	
d3	12.30	12.92	0.484	0.509	
d4	8.64	9.91	0.340	0.390	
E	10.36	10.63	0.408	0.419	4
e	2.54 BSC 0.100 BSC				
L	13.20	13.73	0.520	0.541	
L1	3.10	3.90	0.122	0.158	3
n	6.05	6.15	0.238	0.242	
r	3.05	3.45	0.120	0.136	
s	2.40	2.50	0.094	0.098	6
v	0.40	0.50	0.016	0.020	6
w	3"	7"	3"	7"	
x	45"	45"	45"	45"	

LEAD ASSIGNMENTS

HEXFET

- 1- GATE
- 2- GRAN
- 3- SOURCE

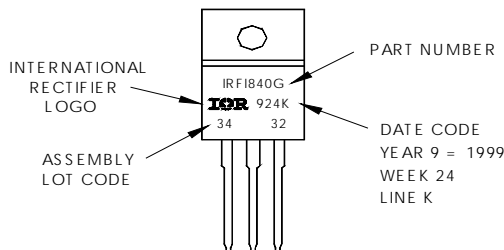
IGBTs CoPAK

- 1- GATE
- 2- COLLECTOR
- 3- EMITTER

## TO-220 Full-Pak Part Marking Information

EXAMPLE: THIS IS AN IRFI840G  
WITH ASSEMBLY  
LOT CODE 3432  
ASSEMBLED ON WW 24 1999  
IN THE ASSEMBLY LINE "K"

Note: "P" in assembly line position indicates "Lead-Free"



Data and specifications subject to change without notice.

International  
**IOR** Rectifier

IR WORLD HEADQUARTERS: 233 Kansas St., El Segundo, California 90245, USA Tel: (310) 252-7105

TAC Fax: (310) 252-7903

Visit us at [www.irf.com](http://www.irf.com) for sales contact information. 06/04